

0.37kW Booster Pump







Instructions for use

June 2024

Features & Benefits

- | | | |
|--|---|---|
| <ul style="list-style-type: none"> ✔ 1-year Quality Warranty ✔ NRCS approved ✔ Energy-efficient | <ul style="list-style-type: none"> ✔ Easy to operate ✔ Automatic start/stop function ✔ Pre-wired with a 3-point plug | <ul style="list-style-type: none"> ✔ Dry running protection ✔ Over-current protection |
|--|---|---|

APPLICATIONS

 Pump 0.37kW	 Bathrooms 1	 or  or  Misting 10 Pop up 2 Impact 1	 Dishwasher Yes	 Washing Machine Yes
---	--	---	---	---

⊕ Get the most out of your purchase!

- Add a **JoJo Pump Cover** to protect your pump from the elements and prolong its lifespan.
- Add a **JoJo Pump-to-Tank Connector Kit** for seamless connection from your pump to a JoJo water tank.

1-year Quality Warranty

JoJo pumps purchased from an approved JoJo retail outlet and/or distributor carry a 1-year warranty from the date of purchase. In order to maintain your warranty, always ensure you install, operate and maintain the pump as per the instructions provided in this manual.

Detailed T's and C's, as well as return policies and procedures are in the back of this manual.

1
YEAR
WARRANTY

Performance table

Pump specifications	
Pump model	QB60
Motor power	0.37kW
Max. flow	34 lt/min
Max. pressure	3.8 bar
Max. fluid temperature	40 °C
Max. ambient temperature	40 °C
Max. suction lift	8m

Flow control switch	
Model	SKD-2
Input voltage	220V
Frequency	50 Hz
Current	10 A
Max. power	1500W 2HP
Protection	IP 65

Best efficiency range

Flow range	
Lt/min	10 to 20 lt

Pressure range	
Bar	1 to 2.4 bar

PERFORMANCE CURVE

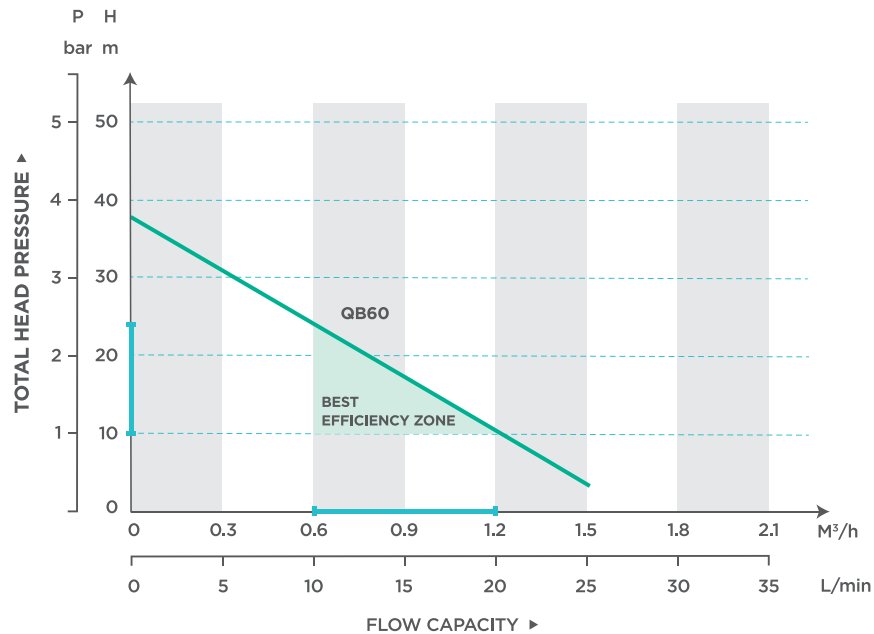

Additional pump details

Inlet and outlet size (inches)	1"
Start-up amps (single phase)	6.2 A
Running amps (single phase)	1.9 A
Weight	9 kg
Dimensions:	
Length	280 mm
Width	140 mm
Height	395 mm

Construction characteristics	
Pump body	Cast iron
Impeller	Brass
Motor shaft	Stainless steel 304
Mechanical seal	Ceramic-graphite



PUMP DIAGRAM

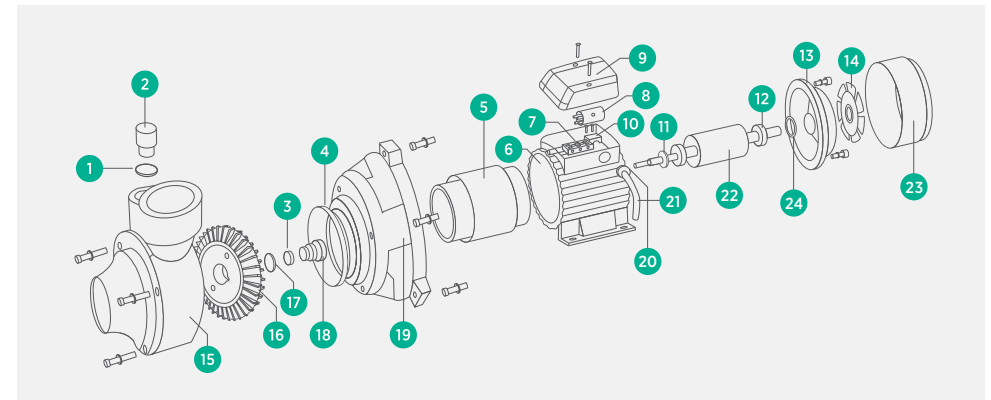

No.	Description	No.	Description	No.	Description
1	O-Ring	9	Terminal cover	17	Shaft circlip
2	Brass air vent screw	10	Cable fixer	18	Mechanical seal
3	Flat washer	11	Flinger	19	Motor bracket
4	O-Ring	12	Bearing	20	Cable protector
5	Stator	13	End cover	21	Cable
6	Stator housing	14	Fan	22	Rotor
7	Terminal block	15	Pump body	23	Fan cover
8	Capacitor	16	Impeller	24	Wave washer

i Important information

- The pump must be earthed with no strain placed on the electrical cable.
- All maintenance should be carried out with the power supply disconnected.
- The pump is designed for clean water use only, i.e. water containing no solid particles. Pumping muddy water or water containing suspended solids will severely reduce the lifespan of the unit and falls outside of the factory warranty.
- Extending the cable will affect your factory warranty. Always make use of an approved extending plug adapter.
- The pump should be installed in a ventilated, undercover area to protect the unit against direct sunlight, rain and spray from any irrigation system. A JoJo pump cover is recommended for best protection.

Recommended suction pipes:	Recommended discharge pipe:
HDPE (minimum 1" or 25mm)	Copper, HDPE or any SABS approved piping (1" or 25mm)
Helical coil reinforced flexible hose 1" or 25mm	

INSTALLATION

Foundation

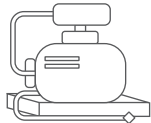

The foundation should be solid enough to support the pump. It is recommended to secure the unit by bolting it to a concrete or paved surface.

Before building the foundation, take the following into consideration:

- The placement of the pump incl. the direction of inlet/outlet.
- The height: ensure that the water level in the tank is higher than the suction side of the pump.

Mounting

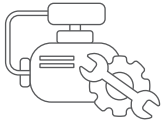

- A level base is essential to ensure the pump shaft is aligned horizontally.
- The pump suction line and fittings must all be on a horizontal plane to ensure there are no high points in the pipeline where air can get trapped.
- The discharge line and fittings must be on a vertical plane.

Piping

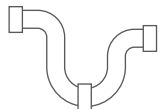

- The suction and discharge pipes should be supported independently by utilising pipe hangers and support blocks - this will prevent strain on the pump joints and casing.
- Before making a connection, always check the pipe alignment to ensure it is correct.
- The inlet and discharge pipe should align with the pump to ensure there are no bends or kinks that might affect the flow.
- The inlet and discharge pipe/connections must correspond with the design specifications of the pump as it may directly affect the efficiency and power consumption of the pump.
- The diameter of the suction and discharge pipe must be equal or greater than that of the ports of the pump.
- When used as an alternative water supply for a home, install non-return valves to ensure no back pressure to the municipal supply or the pump.

PRIMING INSTRUCTIONS

IMPORTANT: always prime the pump before use to ensure proper functionality and to prevent possible damage to any of the components.

01. Ensure that the ball valve between the tank and pump is open.
02. To allow the air in the pump to escape and the pump to be filled with water by gravity feed, unscrew the priming screw. The suction line and pump should slowly fill with water until a steady flow is visible from the air valve. **Note:** This also ensures that all air has been removed from the casing and suction piping.
03. If after a few seconds water is not visible from the air valve, fill the pump volute manually until it is overflowing.
04. Put the priming screw back in place and then tighten. Do not over tighten.

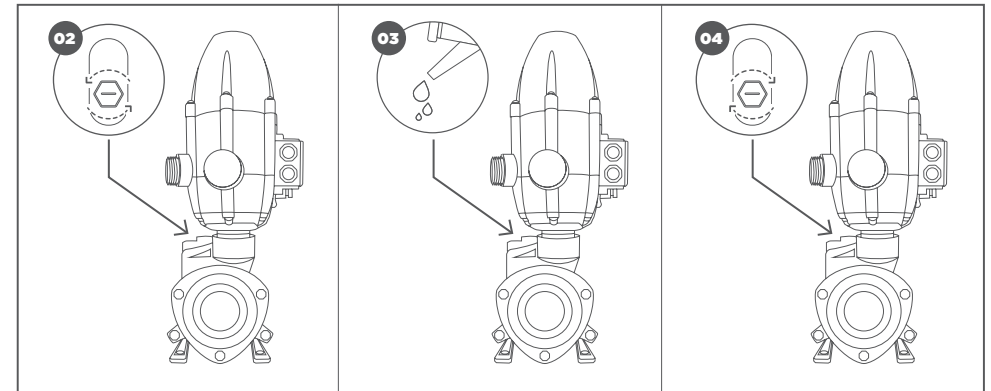

OPERATING INSTRUCTIONS

After priming the pump, do the following to test it and ensure proper operation:

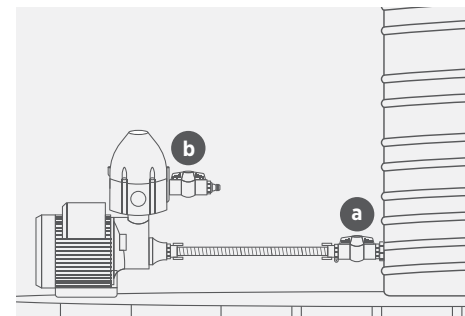

01. Check that the ball valve (a) between the tank and the pump is open and that the discharge valve (b) on the pump is closed. **Note:** It is always advised to install a ball valve between pump and tank for maintenance purposes.

AUTOMATIC PUMP CONTROL

TYPE: PS02.1

RESET

220 - 240 50 / 60 Hz
10Amax. 10BARMAX. IP 65

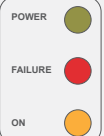

02. Insert the plug into the main power supply and switch the plug on. The power indicator light of the flow controller must be illuminated.

Operating instructions (continued)

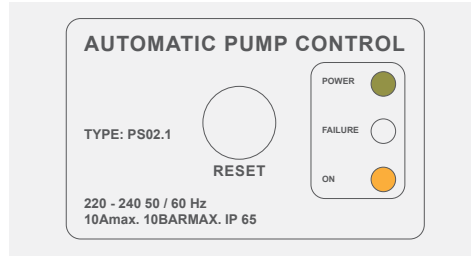

03. Open the discharge valve (b), the pump should start automatically.

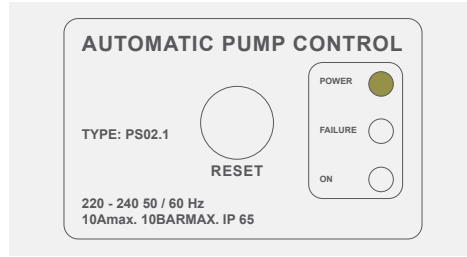

04. Close the discharge valve (b), the pump will switch off within 15 to 20 seconds (this is a built-in safety feature that protects the pump). This tests the pressure controller operation.

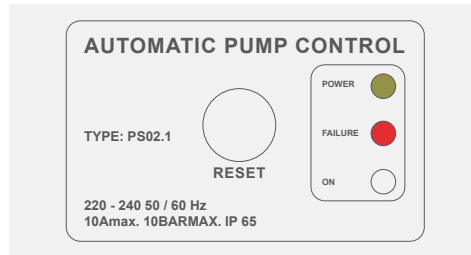

05. Close the inlet valve (a) and open the discharge valve (b). The pump will switch on and run for 15 to 20 seconds. The pump should then stop operating and the failure light on the flow controller should be illuminated. This tests the run dry operation.

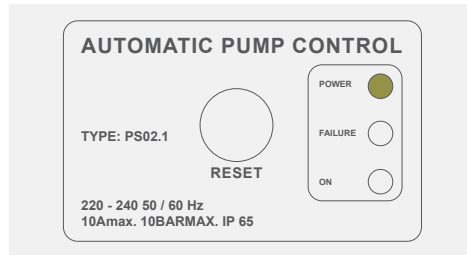

06. Open the inlet valve (a) and press the reset button on the flow controller. The pump will start running.

07. Close the discharge valve and wait for the pump to switch off. Open the discharge valve a little bit so that the pressure on the pressure gauge decreases slowly. Observe at what pressure the pump switches on again. Adjust the adjustment screw to increase/decrease the desired cut-in pressure (the pressure at which the pump switches on). **Note:** The adjustment screw does not determine the pressure at which the pump switches off. **After completing steps one to six, the pump will be ready for use.**

MAINTENANCE INSTRUCTIONS

IMPORTANT: it is advised to run the pump at least once a month to prevent the impeller from getting stuck. Should the impeller get stuck (typically due to sediment in the water), you can follow these guidelines to clean and test it.

To clean the pump, you will require:



A CLEAN CLOTH



SIZE 8 SPANNER



FLAT POINT SCREW DRIVER



WATER PUMP PLIERS



100/120 GRIT SAND PAPER

Open the pump to confirm if the impeller needs cleaning.

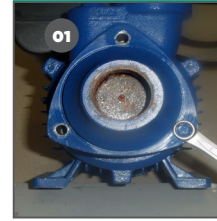

With the pump inlet facing you, remove the 3 x 6mm screws from the front casing.



Split the front cover from the pump.

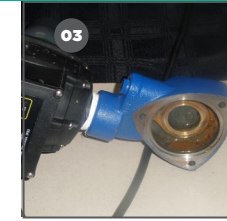

Move the cover away from the pump. Be careful not to damage the electrical cord.

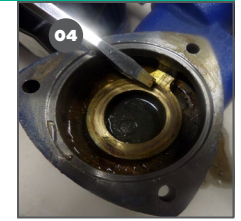

If the wear-plate or impeller is dirty, dirt will be visible as indicated in the image above.

If the impeller needs cleaning, simply do the following:

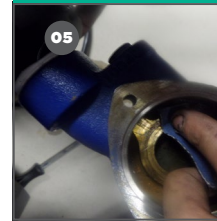

Using a piece of sandpaper gently clean the surface where the impeller runs.

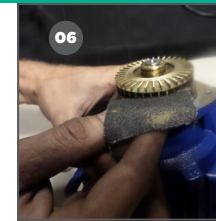

Next clean behind the impeller and casing. Once done, wipe both sides with a cloth.



Make sure the O-Ring is in place (as indicated in the image above), before re-fitting the front cover.

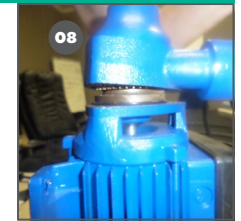

Replace the front cover and refit the 3 x 6mm screws to it.



Tighten the 3 screws on the cover, making sure not to over tighten them.

Test the pump to ensure it has been cleaned properly.

Note: We recommend testing the pump before connecting it to the water supply.

- 10.** Insert the plug into the main power supply and switch it on. The pump should start up immediately and run for 20 seconds, after which it will shut down (a built in safety feature to prevent dry run).
- 11.** Reconnect your pump to your water supply as per the operation instructions on pages 5 and 6 in this manual.
- 12.** Reset the pump by pressing the reset button on the flow controller.

JOJO PUMP WARRANTY

Please read this warranty in conjunction with the South African Consumer Protection Act 68 of 2008.

- 01.** JoJo warrants its pumps to the original end user/purchaser to be free of defective materials and workmanship under normal use for a period of 12-months from the date of purchase from authorised retailers and distributors. To be eligible for warranty repair or replacement, the pump must be returned to the point of purchase during and up to the expiry date of the warranty period. Proof of date of purchase is required.
- 02.** Liability in terms of this warranty shall be limited to repair or replacement of the pump. Liability for any other losses or subsequent damages is expressly excluded.

Pump Warranty (continued)

- 03.** This warranty does not obligate JoJo to bear any cost of removal, installation, transportation, or other charges that may arise in connection with a warranty claim.
- 04.** The warranty shall not apply to repairs or service necessitated by normal wear and tear or for lack of reasonable and proper maintenance.
- This warranty does not apply if in the sole judgement of JoJo the product or any of its components have been;**
- (a) Tampered with, disassembled (unless as per JoJo's specific instructions relevant to peripheral pumps and clearly displayed on fan cover), repaired or altered (except as may be pre-authorized by JoJo in writing);
 - (b) Subjected to misapplication, misuse, neglect or accident; or
 - (c) Used to pump anything for which the pump was not designed. Such use may compromise or harm the pump and/or any of its components.

IMPORTANT: this is the exclusive warranty given by us and no other warranty or guarantees, expressed or implied shall be of any force or effect. No distributor or other person is authorised to assume any liability or obligation for JoJo other than expressly provided herein.

RETURN POLICIES AND PROCEDURES

Refunds

Within 5 days of purchase: as part of the cooling off clause (section 16 of the CPA), the pump may be returned for refund, provided that it is still within the original packaging, unused, and in the original condition.

Within 10 days of purchase: the pump may be returned for refund or replacement if it does not meet the purpose for which intended (section 20 of the CPA), provided that it is still within the original packaging, unused, and in the original condition. In such instance the pump will be returned to JoJo for an evaluation, after which an inspection report will be provided confirming whether it meets the necessary requirements for refund or replacement.

Returns/repairs

Within 12 months: should the pump not operate as specified, or cease to do so within 12 months after being purchased, the return procedure is as follows:

- **Return the pump to the store from which purchased,** together with the proof of purchase (to confirm that it is within the 12-month warranty period). Please ensure that the condition of the pump is as specified in section four of this warranty, and that it is still packed in the original packaging.
- **The store will send the pump to the nearest JoJo factory for an evaluation.**
- At JoJo's election, **(a) the pump will either be repaired** (if repairable) and that repair warranted for three months, or the balance of the 12-month period, whichever period is longer; or **(b) the pump will be exchanged** (this only applies if the pump is non-repairable, and a replacement pump in similar visual condition will be provided by JoJo).
- The evaluation (once the pump is sent back to JoJo), repair/exchange and delivery to the store will take place **within 14 days.**

Our return/repair request form is available on our website at www.jojo.co.za.

Thank you for choosing JoJo. If there is anything that you are unsure about or need assistance with, please do not hesitate to contact us.

www.jojo.co.za | +27 11 695 8300

JoJo
FOR WATER FOR LIFE