

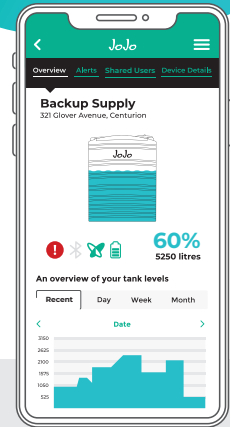

JOJO MONITOR Tank Level

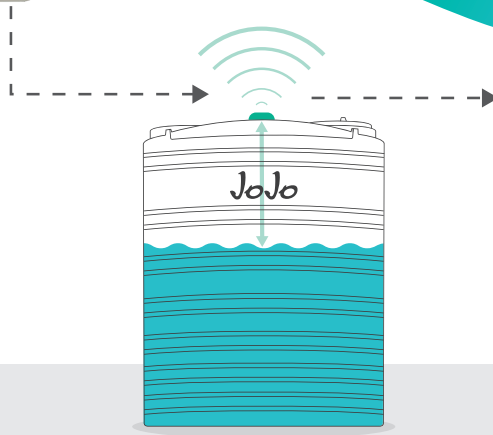

The easy, reliable way to monitor the level inside your tank via your phone.

- ✓ View current and historic water level data
- ✓ Set up alerts and notifications for up-to-date remote monitoring
- ✓ View stored water consumption over a given period

JOJO MONITOR

Tank Level



Monitor device



Sensor

Connectivity options



Bluetooth

- (Within close proximity to your device)
- For initial activation and testing.
- For live readings or real-time monitoring.



Sigfox

- (Remote monitoring of your device)
- To access current and historic data.
- To configure alerts and notifications.
- To view and compare water storage and/or usage over given periods.

What is needed to set up Remote Monitoring?

1

Scan this QR code to check if you have Sigfox coverage



2

Activate your **FREE 12-month subscription** via the **JoJo Monitor App**

Additional components required for installation



A Phillips cross-head screwdriver



A 40mm hole saw



A cordless drill



A 3mm hex Allen key*

*Required when the batteries need to be replaced

WHAT'S IN THE BOX?

1. Monitor device pre-fitted with:

- A** Sensor
- B** 3x 3.6v lithium AA batteries
- C** 2x pieces of double sided tape

2. 5x self-tapping screws

3. 2x cable ties

2.



3.

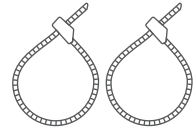

1.

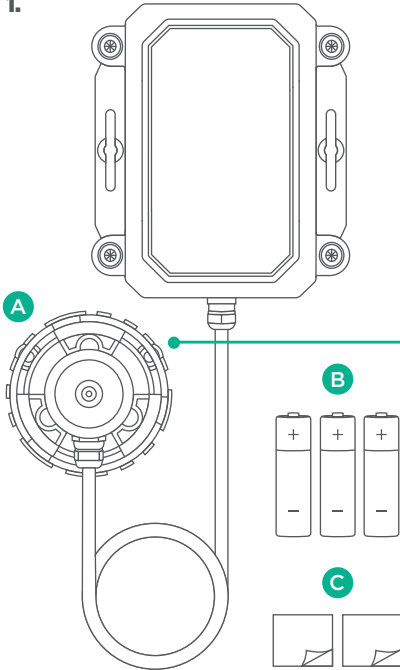

Sensor components (when disassembled)

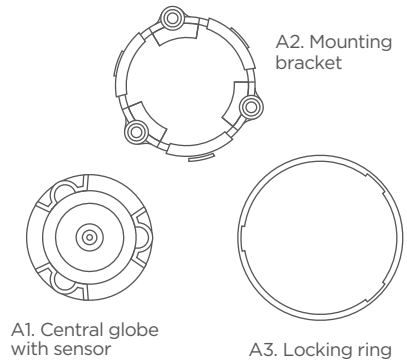

Should you want to remove the globe (A1) from the mounting bracket (A2) turn the locking ring (A3) counter clockwise to loosen it and take it off, then turn the mechanism within the globe vertically so that the cord points upward and gently lift. Reverse the process to re-install.

APPLICATION

The JoJo Monitor Tank Level is the reliable and convenient way to remotely monitor the water levels inside your tank. Installed on top of your tank, it measures the water level via a sensor and sends the data to the JoJo Monitor App on your cell phone. It's that simple!

Installation: Please refer to our installation guide on the following pages for placement recommendations based on your tank type.



This product is locally manufactured in South Africa



Ideal location

It is recommended to install your sensor as close to the centre of the tank as possible, ensuring that it is 100% level and at least 150mm above the highest possible water level of the tank.

Important: To avoid damage and maintain your tank warranty, ensure that no pressure or weight is placed on the tank's lid or roof during device installation. Our tanks are not designed to support additional weight, and any damage sustained as a result will not be covered by your tank warranty.

PLACEMENT RECOMMENDATIONS FOR DIFFERENT JOJO TANKS

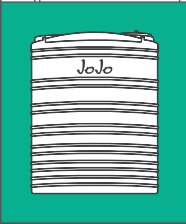
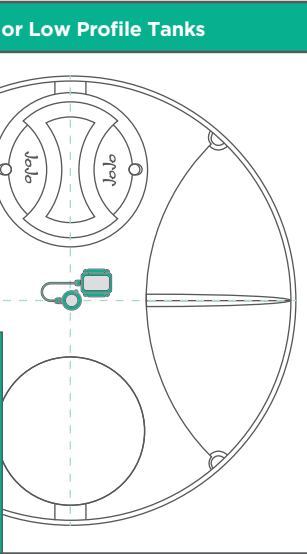
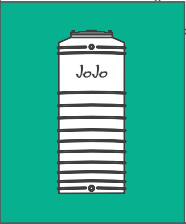
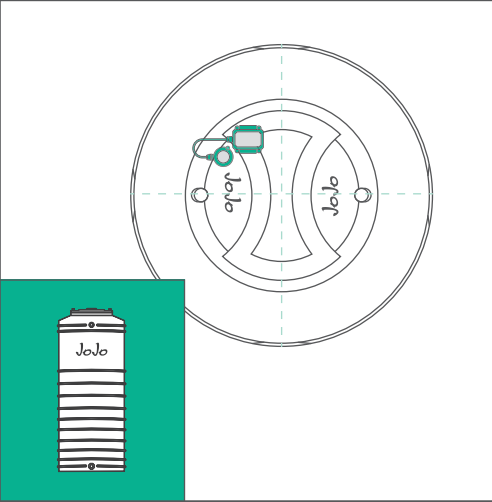
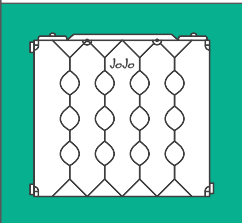
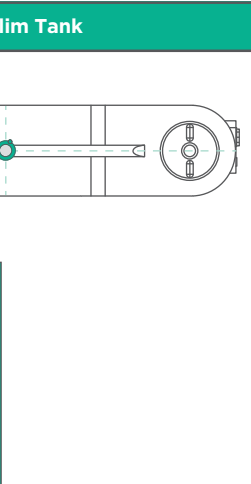
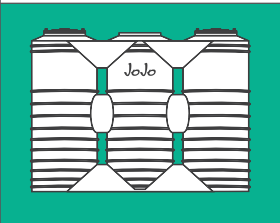
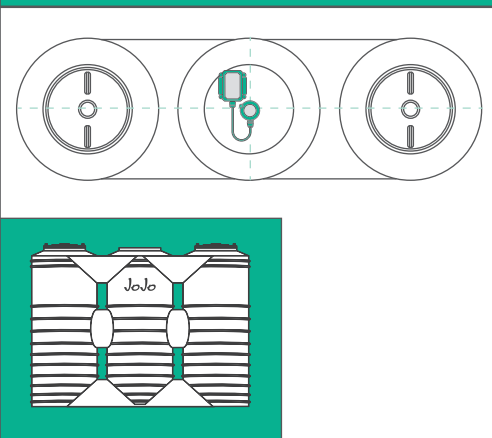
Vertical or Low Profile Tanks		Slimline Tanks	
			
Side view	Top view	Side view	Top view
SuperSlim Tank		MultiSlim Tank	
			
Side view	Top view	Side view	Top view

PRE-INSTALLATION

Important: Before installing the device on top of your tank, please download the JoJo Monitor app and follow the prompts to link your device to your account. This requires you to activate your device, and enter your device specific serial number which is on the back of your device.



Scan this QR code

to download the **JoJo Monitor app** and set up your device.
Or visit www.jojo.co.za/jojo-monitor-devices for more info.



INSTALLATION

- 01** Refer to the placement recommendations provided to find the best location to install your Tank Level based on your tank type. **Note:** If your tank type is not mentioned, it is advised to find the highest, most level point on your tank for the most accurate readings.
- 02** Attach the 40mm hole saw bit to your drill and drill a hole in the recommended location. **Important:** Once done, clean the area in and around the hole to remove any plastic shavings.
- 03** Before installing the sensor (**A**) you will need to first remove the locking ring (**A3**) by unscrewing it anti-clockwise and lifting it up. This will give you access to the screw holes in the mounting bracket (**A2**).
- 04** Secure the mounting bracket (**A2**) in place by using 3 of the self-tapping screws (**2**) provided. You can use the built-in spirit level as well as **test mode** to ensure that your sensor is level and properly aligned.
- 05** Once you are sure that your sensor is level, it is important to lock it in place to ensure it does not shift. To do this, put the locking ring (**A3**) over the mounting bracket (**A2**) and turn it clockwise.
- 06** Once the sensor (**A**) is secured, you can secure the monitor device (**1**) in place with either the 2 remaining self-tapping screws, the double-sided tape (attached to the back), or the cable ties.

IMPORTANT INFORMATION

To ensure proper device operation and communication please take note of the following:

- ✓ Never place your device inside metal or concrete containers, enclosures or confined spaces. Do not fully enclose or submerge the unit as this could have an impact on its performance.
- ✓ For best accuracy, it is advised to have a minimum gap of 150mm between your highest possible water level and your sensor.
- ✓ The measurable range of the sensor is from 150mm to 5 000mm.
- ✓ It is recommended to install your sensor as close to the centre of the tank as possible to avoid interference with the side wall as that could result in inaccurate readings.
- ✓ Remote monitoring signal coverage is hampered when installed indoors, underground, or within a basement of a building and, as a result, limits communication between the device and network.

Device button functionality

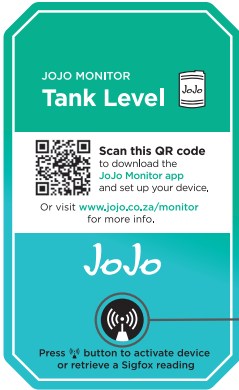

Activate the device

During setup within the JoJo Monitor App you will be prompted to activate your device and link it to your account. **To do this, press the button on your device once.** Upon release you will hear 4 long beeps followed by 1 short beep to confirm that it has been activated. If you only hear 1 beep, the device is already activated and ready for use.

Put the device in test mode

We recommend using test mode while installing your device to ensure proper functionality. Simply follow these steps:

Enter test mode

Press and hold the button for 5 seconds. Upon release you will hear 2 long beeps to confirm that the device has successfully entered test mode.

Test your sensor alignment

While in test mode, check that your sensor is level and properly aligned.

The buzzer is influenced by alignment and will sound with periodic beeps to indicate the signal quality with indications as follows:

Bad signal = 3 seconds between beeps

Good signal = fast consecutive beeps

Exit test mode

Press the button once. If the button is not pressed the device will remain in test mode for 10 minutes, after which test mode will automatically conclude.

Device battery status

Your device battery status will be visible on your device dashboard at all times and indicated as follows:



REPLACING BATTERIES

- 01** Use a 3mm hex Allen key to remove the four screws from the corners of the monitor device.

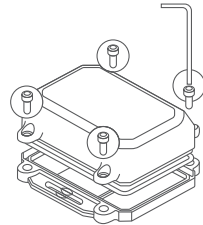

- 02** Remove the back cover and replace the batteries as per the orientation indicated. **Note:** It is advised to only use 3.6v lithium AA batteries and to not use old and new batteries together.

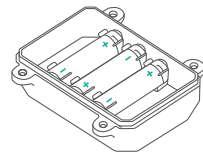

- 03** Close the cover, place the four screws back in place and firmly secure them with the allen key.

